



# 400 Series Kamado Grill

## Owner's Manual

**Welcome to Kamado cooking!** Our Icon Kamado is based on 3,000+ years of clay pot cooking from around the world. Over generations our ancestors have continued to refine Kamado techniques for grilling, smoking, baking and cooking all types of food, including meats, poultry, fish and vegetables. Kamado cooking locks in moisture and provides a variety of ways to infuse different tastes into your foods, turning weekend grillers into neighborhood chefs.

Our Icon Kamado builds on this heritage with fresh aesthetics, safety and convenience features, a user-friendly easy-lift lid with spring assist and high-quality materials to define a new industry standard for design and innovation. The thick ceramic construction of our grill provides superior thermal insulation allowing you to grill, cook, bake or smoke regardless of the season - from the hot summer days in our home town of St. Louis to the cold snowy days in Bangor, Maine.

In this manual we provide the basics to get you cooking and invite you to our website, [www.icongrills.com](http://www.icongrills.com), where we share recipes, detailed Use & Care information and contact information if you need more help.

From our entire team here at Icon Grills, thanks for your purchase. Here's to becoming the destination eatery in your neighborhood!



## Cooking with your Kamado

Your new Icon Kamado is the complete outdoor cooking appliance that allows you to sear, grill, bake and smoke all types of food. For best results, we recommend using natural lump charcoal made from hardwoods. Compared to briquettes, natural charcoals start faster, burn cleaner and longer, reach higher temperatures and produce less ash. Leftover natural charcoal also relights for re-use. Before restarting the grill, knock off excess ash from remaining charcoal. Routinely empty ash, but only do so when grill is cool.

Starting your Icon Kamado Grill is simple and fast: Open top and bottom vents wide open, fill the inner fire bowl with enough charcoal to cover the air holes, then light the charcoal using an electric starter or approved grill starters. After several coals are burning, spread evenly, adjust top and bottom vents, and wait for the Kamado to reach your desired cooking temperature. As needed, add more charcoal by using the flip grate feature, being careful not to burn yourself with the hot food or cooking grate.



# SET-UP

## Step 1: Cart Assembly

- Remove bolts, washers and locking washers from the two "X" connectors.
- Remove paper washers and begin assembling the "X" connectors and legs.
- Please Note: Top & Bottom "X" connectors must be assembled simultaneously.
- Assemble cart by inserting the two "X" connectors into leg ends and install bolts and washers in the same order they were removed from "X" connectors.
- While assembling, only finger-tighten bolts to allow for adjustment in cart. Otherwise it can be difficult to get all the bolts inserted.
- Screw in Standard Rubber Wheels to rear Cart Legs and the Locking Rubber Wheels to the front Cart Legs.
- Tighten nuts using wrench provided.
- After cart is assembled, confirm all bolts are tightened.

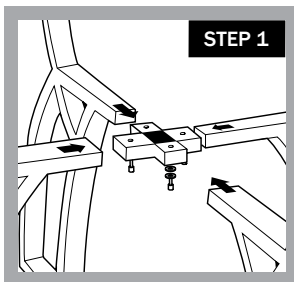

## Step 2: Shelf Brackets

- Remove nuts and washers from bolts welded on the bottom banding and remove paper washers.
- Mount shelf brackets over studs with bracket slots facing up. Brackets are stamped on the back with letters indicating their position (e.g., LF=Left Front and RB=Right Back).
- Mount flat washer then acorn nut on each stud and tighten with wrench provided.

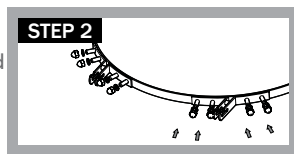

## Step 3: Grill Assembly

- Take all parts out of grill before lifting. The grill is heavy and will require two people to lift and guide the Kamado into cart.
- Be sure the Ash Drawer is centered between the two front legs and the grill is resting against the two back legs.
- Lower fire bowl into grill with the ash drawer opening lined up with the opening in the main ceramic body. Place cast iron charcoal grate with attached starter pocket into fire bowl (Step 3a). Align tabs of starter pocket with electric starter port in fire bowl.

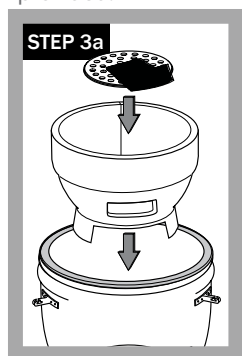

- Place cooking grates onto grill with hinged section facing towards front of grill.
- Close lid and press top vent onto grill with calibrations facing the front (Step 3b).

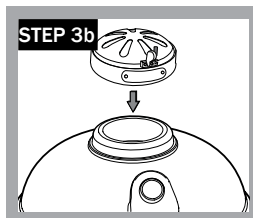

## Step 4: Lava Stone & Bracket Assembly

- Open grill and take off grill grates to expose fire bowl.
- Spread bracket so it makes an "X" shape and lower onto fire bowl, allowing the bracket to rest on edge of bowl.
- Lower Lava Stone onto the bracket.

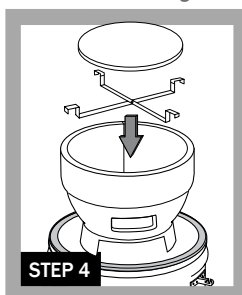

## Step 5: Handle and Side Shelf Mounting

- Remove nuts and washers from bolts welded on the top banding opposite the hinge.
- Remove paper washers and attach handle bracket over studs. On each stud place a flat washer and an acorn nut, then tighten.
- Mount side shelves by inserting the shelf rod into the shelf bracket. Tilting the shelf up slightly and sliding in or out allows you to deploy or store the shelves.

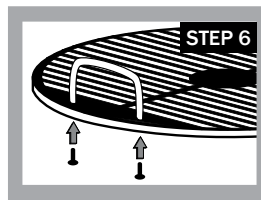
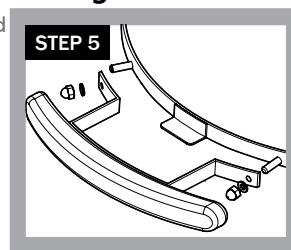

## Step 6: Cast Iron Cooking Grate Assembly

- Remove stainless steel handles and bolts from package. Line up handles and bolts with holes in Cast Iron Cooking Grate & tighten.

## Step 7: Using the Electric Starter

- Place required amount of charcoal inside fire bowl and open all bottom and top vents to maximize air flow.
- Flip open electric starter door and insert electric starter as far in as possible. Plug in electric starter.
- Wait until edges of charcoal turn white and flames are licking the mound of charcoal. On average it takes 8-12 minutes to start charcoal.
- Unplug starter and remove from Starter Door. Be careful when removing electric starter, the element will be very hot. After use, let element rest on support and cool completely away from children.

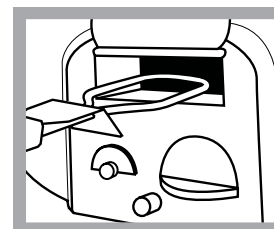

NOTE: Do not plug the electric starter in while it is raining unless you're in a safe and securely covered area.

## Step 8: Ash Drawer Usage

- Once grill is cool, it is safe to remove ash from ash drawer.
  - Using bottom knob on Ash Drawer, lift slightly (Step 7a) and pull drawer out (Step 7b).
  - Once ash is emptied, reinstall by pushing Ash Drawer back into grill body until it drops down back into place.
- WARNING: ALWAYS WAIT FOR ASH TO COOL BEFORE REMOVING ASH DRAWER. NEVER PULL OUT ASH DRAWER WHILE GRILL IS HOT.

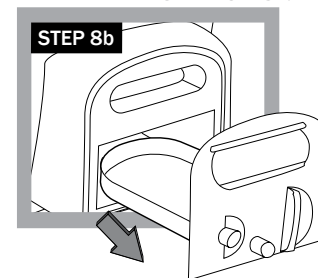
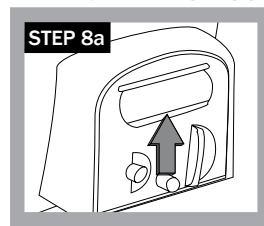

# WARNING

**PLEASE READ THE ENTIRE MANUAL BEFORE OPERATING YOUR ICON KAMADO.  
PLEASE KEEP THIS MANUAL FOR FUTURE REFERENCE.**

ATTENTION! Use caution when cooking, as grill surfaces get hot. To avoid burns, always use protective gloves to adjust top and bottom vents when grill is in use. Do not wear loose clothing near the grill.

ATTENTION! This barbecue will become very hot, do not move it during operation. For outdoor cooking use only. Do not operate grill indoors or in an enclosed space. Use grill only in well-ventilated areas. Keep immediate area around the grill free from combustible materials. Allow for at least 3 feet/1 meter of clearance around grill (house, other outdoor products, hanging tree limbs, shrubs, etc.)

WARNING! Keep children and pets away from the grill at all times.

Do not allow children to operate grill. Never leave grill unattended when in use.

Grill should be placed securely on a level base prior to use. Only operate grill on a hard, stable, level surface (concrete patio, ground, etc.) capable of supporting the weight of the grill when loaded with food. Never operate grill on wood support surface, wood deck or like combustible support surfaces. Never attempt to move grill when in operation or cooling down. Never operate this grill within 25 feet/7.5 meters of any flammable liquid. Never operate this grill within 10 feet/3 meters of a gas cylinder. The grill should not be placed under combustible structures, like garages, porches, patios, or carports. Burning charcoal produces carbon monoxide, an odorless gas, which can cause death.

The use of alcohol, prescription or non-prescription drugs may impair the operator's ability to properly assemble or safely operate the grill.

Do not use on boats or recreational vehicles.

CAUTION: Never use lighter fluid, gasoline, or other volatiles to start your charcoal, as it is dangerous and will leave a residual taste in your food. Use only firelighters complying to EN 1860-3. Use utmost care when adding charcoal to grill. Electric start-up is recommended. Dispose of cooled ash by placing it in aluminum foil, soaking with water and discarding in a non-combustible container. Always wait for grill to completely cool before opening built-in ash drawer.

When cooking above 500°F/260°C, with both top and bottom vents closed, rapidly opening the lid creates a sudden rush of oxygen into the grill, which can cause a flare-up. When in this cooking mode, we recommend that, prior to opening the lid, you open top and bottom vents to allow oxygen to stabilize inside the grill, minimizing the possibility of a flare-up.

[www.icongrills.com](http://www.icongrills.com) [help@icongrills.com](mailto:help@icongrills.com) 1-877-917-4273  
Icon Grills 1531 Fairview Avenue, Suite B, St. Louis, MO 63132

# PARTS

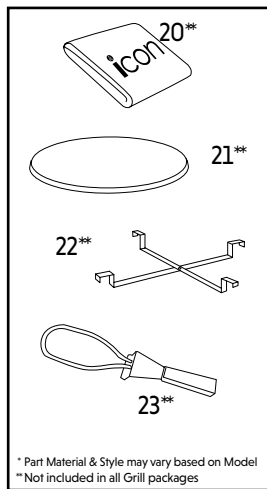

\* Part Material & Style may vary based on Model  
\*\* Not included in all Grill packages

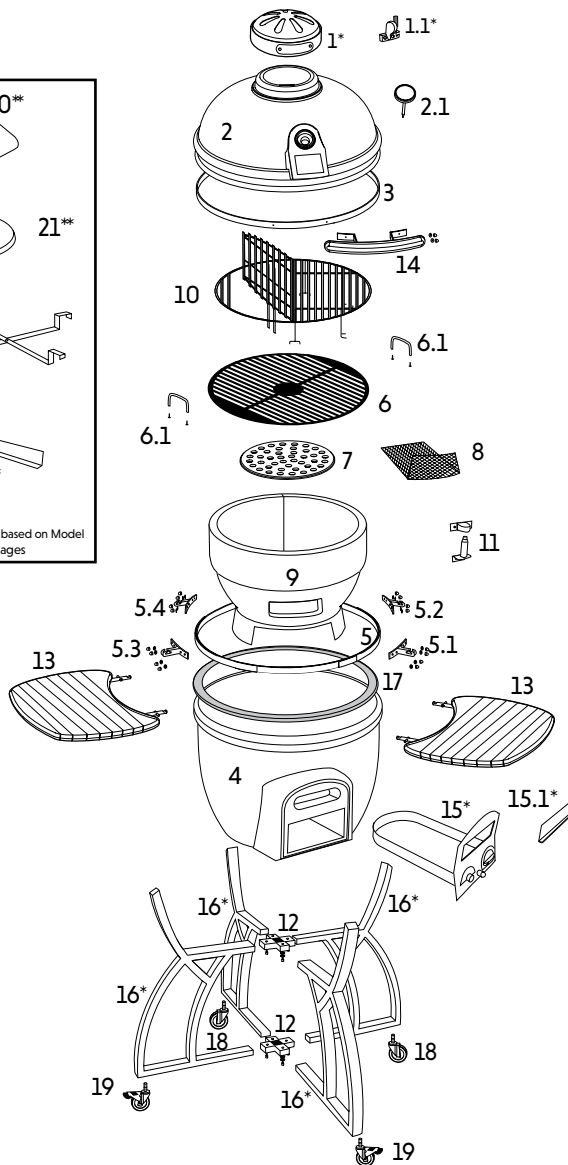

| PART NAMES   | PART NUMBERS   |
|--|----------------|
| 1 Cast Iron Top Vent   | VGC TV-CAS     |
| 1.1 Bakelite Tab with Stopper Pin                            | VGC TV-CA-TSP  |
| 2 Ceramic Dome Lid   | VGC CDLSS-1    |
| 2.1 Thermometer  | ICN SSIT       |
| 3 Top Ring Assembly  | VGC RA1-L      |
| 4 Ceramic Dome Bottom  | VGC SSDB-L     |
| 5 Bottom Ring Assembly                                       | VGC RA2        |
| 5.1 Right Front Side Shelf Bracket (with nuts & washers)     | VGC SB-RF      |
| 5.2 Right Back Side Shelf Bracket (with nuts & washers)      | VGC SB-RB      |
| 5.3 Left Front Side Shelf Bracket (with nuts & washers)      | VGC SB-LF-L    |
| 5.4 Left Back Side Shelf Bracket (with nuts & washers)       | VGC SB-LB-L    |
| 6 Cast Iron Bottom Cooking Grate                             | ICN CGB-L      |
| 6.1 Handle for Cast Iron Grate (with bolts) (x2)             | ICN CGB-H      |
| 7 Charcoal Grate   | VGC CG-1       |
| 8 Electric Starter Pocket                                    | VGC ESP-1      |
| 9 Fire Bowl  | VGC FB-1       |
| 10 Stainless Steel Top Cooking Grate                         | VGC CGT-L      |
| 11 Shock Absorber Assembly                                   | VGC AC-L       |
| 12 "X" Leg Connectors (with bolts, washers & spring washers) | ICN XLC-L      |
| 13 Wood Shelves, Slatted, Dark (x2)                          | VGC WS-SD-L    |
| 14 Handle (with nuts & washers)                              | ICN HDLSS-L    |
| 15 Ash Drawer Body, Powder Coat                              | ICN ADB-PC     |
| 15.1 Starter Port Flipper Door, Powder Coat                  | ICN ADB-PCFD-L |
| 16 Cart Leg, Curved, Powder Coat (x4)                        | VGC CLEG-PC    |
| 17 Felt Gasket   | VGC FLT-L      |
| 18 Rubber Wheels (x2) Standard                               | VGC WHLS-L     |
| 19 Rubber Wheels (x2) Locking                                | VGC WHL-L-L    |
| 20 Grill Cover   | ICN GC-L       |
| 21 Lava Stone  | VGK-101R       |
| 22 SS Stone Bracket  | VGK-BRACKET    |
| 23 Electric Starter  | VGK-ELEC       |

# WARRANTY

Subject to the following terms and conditions, Phase 2, LLC, d/b/a Icon Grills ("Icon Grills"), warrants to the original purchaser that the ceramic cooker manufactured or supplied by Icon Grills will be free from defects in material and workmanship under normal use for the following periods from the original date of purchase: limited lifetime for all ceramic parts, five (5) years for all metal parts, one (1) year for temperature gauge, gaskets and cover, 90 days for side shelves, electric starter and lava stone & bracket. This Limited Lifetime Warranty is contingent upon purchaser registering the product at [www.icongrills.com/register](http://www.icongrills.com/register) within 30 days from the date of purchase along with a copy of the original dated sales receipt, which can be attached in an electronic format (i.e. scan, photograph, etc.) to an email sent to [help@icongrills.com](mailto:help@icongrills.com). Failure to do so will invalidate the warranty. Any chips or cracks in the finish of the ceramic cooker present at the time of purchase must be noted on the original dated sales receipt. This Warranty is not transferable to subsequent owners. If you cannot register online, contact Icon Grills customer service at (877) 917-4273 or email [help@icongrills.com](mailto:help@icongrills.com).

If any product covered by this Warranty is defective due to a covered warranty condition, such product will, at the option of Icon Grills, be repaired to its original condition or replaced with a comparable new product or part. The repair and/or replacement of parts shall constitute the extent of the liability and obligations of Icon Grills under this Warranty. Purchaser is required to provide photographic evidence to assess the damage when submitting claims.

Scratches, cracks, chips, dents, crazing, or minor cosmetic blemishes of the exterior glaze not affecting performance are not covered under warranty, as determined by Icon Grills.

This Warranty does not cover damages caused by improper assembly, improper care, failure to follow directions of use, misuse, abuse, negligence, extreme environmental conditions, normal wear and tear, accidents, acts of nature, or unauthorized repair, alteration or modification, as determined by Icon Grills. This Warranty does not apply to chips or cracks in the ceramic cooker which may occur after the ceramic cooker is purchased by the original purchaser. Icon Grills is not liable for any default or delay in its performance under this Warranty that is caused by any circumstances beyond its control. This Warranty will be invalidated if any liquids, including starter lighter fluid, are poured on or in the ceramic cooker. The protective coating of the ceramic cooker can be compromised by substances or conditions that are beyond the control of Icon Grills. While Icon Grills uses rust-resistant materials, the Warranty as to metal parts does not cover rust or oxidation unless the structural integrity of the ceramic cooker is compromised as determined by Icon Grills.

This Warranty does not cover purchases from unauthorized resellers and/or third parties. Warranty coverage is limited to products purchased at an authorized reseller only.

Commercial use and related applications are not covered under this Warranty. Warranty coverage is based on normal residential use and maintenance.

Icon Grills shall not be liable for any delay or default under this Warranty caused by any event or contingency beyond the control of Icon Grills. This includes acts of nature, fire, government restrictions or restraints, strikes, reduced supply of materials or transportation delays.

THIS WARRANTY IS THE EXCLUSIVE WARRANTY OF ICON GRILLS. ICON GRILLS EXPRESSLY DISCLAIMS ANY AND ALL OTHER WARRANTIES, EXPRESS OR IMPLIED, INCLUDING WARRANTIES OF FITNESS, MERCHANTABILITY, OR FITNESS FOR A PARTICULAR PURPOSE. THIS WARRANTY DOES NOT COVER, AND ICON GRILLS IS NOT LIABLE FOR, ANY DAMAGES RELATING TO LOSS OF TIME, LOSS OF USE OF EQUIPMENT, INCONVENIENCE, OR ANY INCIDENTAL, SPECIAL AND/OR CONSEQUENTIAL DAMAGES. PURCHASER'S EXCLUSIVE REMEDY FOR BREACH OF THIS WARRANTY SHALL BE LIMITED AS SPECIFIED HEREIN TO REPLACEMENT OR REPAIR OF THE AFFECTED PRODUCT.

Some states do not allow limitations on how long an implied warranty lasts or the exclusion or limitation of incidental or consequential damages, so the above limitations and exclusions may not apply to you. This Warranty gives you specific legal rights, and you may also have other rights which vary from state to state. Icon Grills does not authorize any person or entity to assume any obligation or liability on its behalf in connection with the sale and purchase of any of its products. The purchase of any Icon Grills product from anyone other than Icon Grills or an authorized dealer will void the Warranty associated with the product. If you have a question regarding the identity of an authorized dealer, you should contact Icon Grills before you purchase the product.

To submit a warranty claim, the original purchaser or authorized agent of the original purchaser must contact Icon at (877) 917-4273 or contact Icon Grills via email ([help@icongrills.com](mailto:help@icongrills.com)) or through the website at [www.icongrills.com](http://www.icongrills.com).

## Long-Term Maintenance

- Cover your grill when not in use to extend life and maintain appearance.
- When moving grill, always pull by the back hinge.

# STARTING

## Step 1: Measure Charcoal

Set bottom vents wide open and open lid. Fill the fire bowl with enough charcoal to cover the air holes. For smoking foods at low temperatures for longer periods of time (1.5 hours+) you will need to add a little more charcoal, up to approximately 2 inches/5 centimeters above the same air holes. Mound charcoal over perforated stainless steel electric starter pocket. Use lump charcoal for best results.

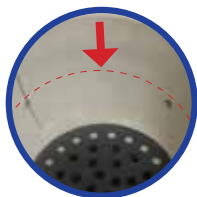

## Step 2: Start Charcoal

Keep lid open. Open the electric starter flipper door and insert starter as far as possible then plug in. Wait until edges of charcoal turn white and flames are licking the mound of charcoal. It takes approximately 8 - 12 minutes to start the charcoal. After coals are started, unplug electric starter and let element rest on support and cool completely away from children.



Electric Starter sold separately on some models.

## Step 3: Set Temperature

Once charcoal is lit, level it out for even heat distribution and close the lid. Set top and bottom vents to the desired setting (refer to the Setting Temperature section in this manual for specific calibrations to use to attain desired cooking temperature). Give your Kamado 8 - 12 minutes to settle into the cooking temperature you want before putting food on the grill.  
**NOTE: If smoking, do not let temperature exceed 275°F/135°C.**

- A) Spread hot charcoal evenly over grate.
- B) Set top and bottom vents for desired cooking temperature.
- C) Let temperature stabilize.

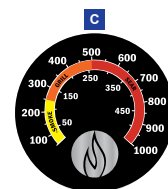
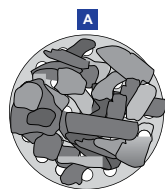

## Step 4: Get Cooking

Use a wire grill brush to clean the cooking grate. That's it - you are ready for the best cooking experience of your life. Go to our website for recipes.

## Step 5: Ash Removal

Always let ash cool before removing ash drawer. Prior to each use, lift and pull out Removable Ash Drawer and dispose of ash.

# SETTING TEMPERATURE

**Icon Grills Kamado cooking temperatures are controlled by adjusting the calibrated top and bottom vents.**

Increasing air flow through top and bottom air vents increases cooking temperature, while decreasing air flow lowers the cooking temperature. Closing both top and bottom vents starves the charcoal of oxygen and stifles down the fire.

\*Caution - If you're going to smoke, do not let the grill get too hot. Keep the temperature low, it takes hours to cool down.

\*Caution - Continuous grilling at extreme high temperatures may cause the felt to burn.

### Prevent Flare-Ups:

If the lid is lifted too quickly, oxygen will rush inside the grill, causing a flare-up. To prevent a flare-up, lift the lid 1 inch/2.5 centimeter and count to five before slowly opening the lid wide open.

\*Temperature Settings are approximate. Many varying factors may give you different results with controls, such as lump charcoal quality, altitude, wind, outside temperature, dew point, barometric pressure, humidity, etc.

|                 | TOP VENT |  | BOTTOM VENTS |
|-----------------|----------|--|--------------|
| <b>SEARING</b>  |          | <b>500° + F</b><br><b>260° + C</b>         |              |
| <b>GRILLING</b> |          | <b>300° - 450°F</b><br><b>149° - 233°C</b> |              |
| <b>SMOKING</b>  |          | <b>225° - 250°F</b><br><b>107° - 221°C</b> |              |

# COOKING TEMPERATURE

All cooking times and temperatures are approximate. Visit [foodsafety.gov](http://foodsafety.gov) for additional information on safe minimum cooking temperatures.

## SMOKING

|                                | Approximate Cooking Time | Smoker Temp (°F) | Meat Temp. (°F)       |
|--------------------------------|--------------------------|------------------|-----------------------|
| <b>BEEF</b>                    |                          |                  |                       |
| Brisket (8 - 12 lbs)           | 1.5 hours/lb             | 225 - 250        | 185 - 205             |
| Short Ribs                     | 5 hours                  | 225 - 250        | Pulls back from bones |
| Tenderloin (3 - 4 lbs)         | 1-4 hours                | 225 - 250        | 120 - 160             |
| <b>PORK</b>                    |                          |                  |                       |
| Baby Back Ribs (1.5 - 2.5 lbs) | 5 hours                  | 225 - 250        | Pulls back from bones |
| Shoulder / Butt (6 - 8 lbs)    | 1.5 hours/lb             | 225 - 250        | 170 - 205             |
| Ham (Bone In)                  | 1.5 hours/lb             | 225 - 250        | 160                   |
| Spare Ribs (2.5 - 3 lbs)       | 5 - 7 hours              | 225 - 250        | Pulls back from bones |
| Tenderloin (1.5 - 2 lbs)       | 2.5 - 3 hours            | 225 - 250        | 160                   |
| <b>POULTRY</b>                 |                          |                  |                       |
| Turkey (Whole)                 | 15 - 20 min./lb          | 240 - 275        | 170                   |
| Chicken (Whole: 2.5 - 4.5 lbs) | 2.5 - 4 hours            | 250 - 275        | 170                   |

## GRILLING (350 - 450°F)

|                          | Beef Temp (°F)    | Pork Temp (°F)    |
|--------------------------|-------------------|-------------------|
| Rare                     | 125 + 3 min. Rest | -----             |
| Medium-Rare              | 130 - 135         | 145 + 3 min. Rest |
| Medium                   | 135 - 140         | 150               |
| Medium-Well              | 140 - 150         | 155               |
| Well-Done                | 155+              | 160+              |
| Ground                   | 160               |                   |
| <b>Poultry Temp (°F)</b> |                   |                   |
| Dark Meat                | 165 - 175         |                   |
| White Meat               | 165               |                   |
| Ground                   | 170 - 175         |                   |